

Pressure Gauges with Bourdon tube Standard version

Nominale size ND 40 ,50 and 63
Accuracy class 1,6 and 2,5

According to DIN EN 837-1

Features

Plastic case ABS
Copper alloy measuring system



Applications

Air -conditioning
Pneumatic systems
Heating systems
Hydraulic systems

Model and ND	MR-10 40	MR-14 40	MR-10 50	MR-14 50	MR-10 63	MR-14 63
Connection	bottom	back centric	bottom	back centric	bottom	back centric
Accuracy class	2,5				1,6	
Ranges in bar	0...0,6, *) 1, 1,6, 2,5, 4, 6, 10, 16, 25, 40, 60, 100, 160, 250, 400 -1 / 0, -1 / +0,6, -1 / +1,5, -1 / +3, -1 / +5, -1 / +9, -1 / +15,					
Application	Constant load 3/4 x end of scale value Alternating load 2/3 x end of scale value Short-time : end of scale value					
Case	Plastic,black (ABS)				Plastic,black (ABS) or steel black	
Window	Plexiglass clipped on					
Dial	Aluminium white, Skale black					
Pointer	Aluminium,black					
Movement	CuZn alloy					
Measuring element	Cu alloy					
Connection	CuZn alloy					
Connectionthread	G 1/8 B o. Z. or G 1/4 B		G 1/4 B		G 1/4 B	
Temperatures	Media : -20°C bis 60°C, Ambient : -40°C bis 60°C					
Weight	0,07 kg	0,07 kg	0,08 kg	0,07 kg	0,15 kg	0,15 kg

*) for ND 40 Range 0...0,6 bar not possible

Dimensions

Connection bottom

Connection back

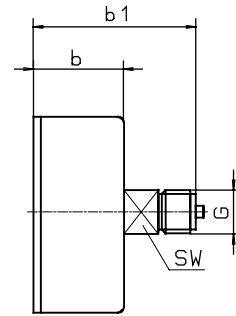
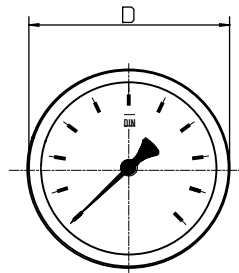
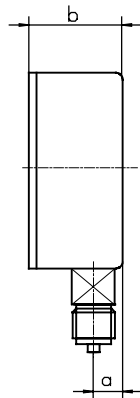
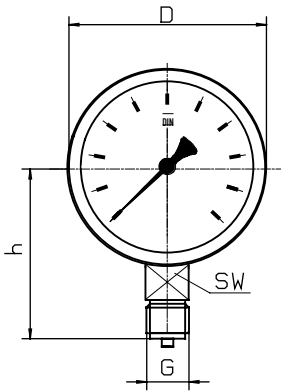

Front flange

Rear flange

Front flange

with triangle bezel and U-clamp

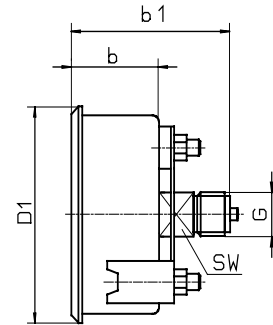
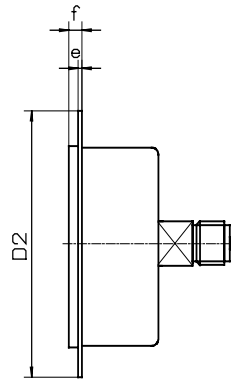
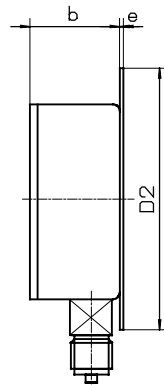
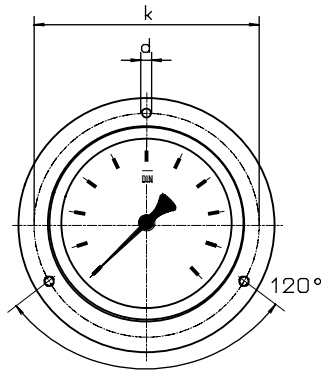

Dimensions in mm														
Model	NG	D	a	b	b1	h	D1	D2	e	f	k	d	sw	G
MR-10	40	40	8	24	-	40	44	61	4,5	6,5	51	3,6	14	G 1/4 B
MR-14	40	40	-	24	47	-	44	61	4,5	6,5	51	3,6	14	G 1/4 B
MR-10	50	50	10	27	-	45	54	72	5	7	60	3,6	14	G 1/4 B
MR-14	50	50	-	27	48	-	54	72	5	7	60	3,6	14	G 1/4 B
MR-10	63	63	10	28	-	54	67	85	5	7	75	3,6	14	G 1/4 B
MR-14	63	63	-	28	49	-	67	85	5	7	75	3,6	14	G 1/4 B

Modelspecification

Model	Connection	Nominal size	Range	Options
MR-1	0 or 4	40, 50 or 63	f.e. 10 bar	

Bottom = 0
Back centric = 4

after rangespecification
for 10 bar = 010

for example : front mounting flange

ND 40 = 40
ND 50 = 50
ND 63 = 63